

: wing cross section)

75

35,7

14

Ø3,5

Ply 1  
B 2

Glue some 5 mm thick balsa  
and sand into shape shown here

51

bar cap spruce or maple 3x3

shear web B 2

shear web B/2

Section B-B

B

B

C

C

7

7

1.5



B 6x8 sand

B 6x7 sand

B 6x10

Ø3,5

ing B 1

6

6

6

20

Al or plastic tube.  
Steel wire 1,5mm

34

Attachment of servo  
according to its size.

Simplified solution of pushrods.

130

165

285

60

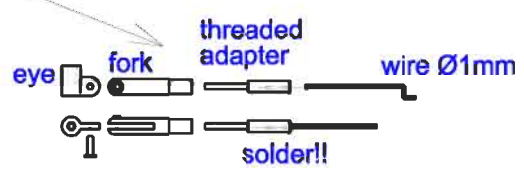
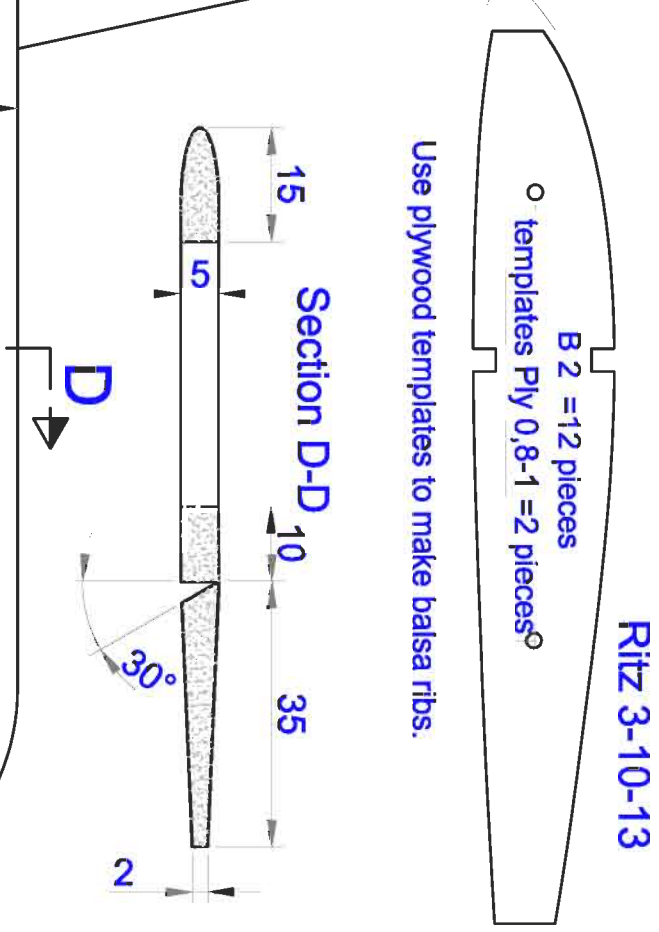
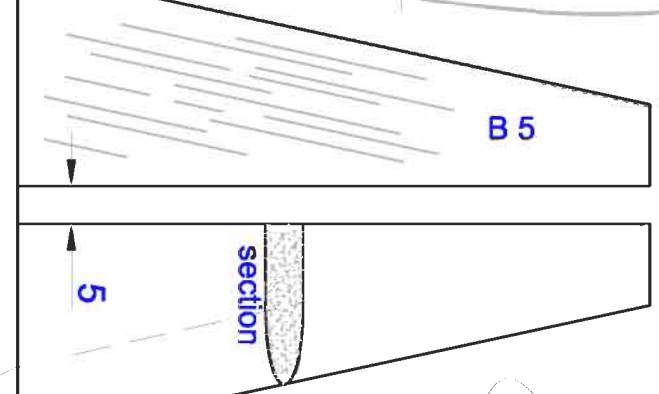
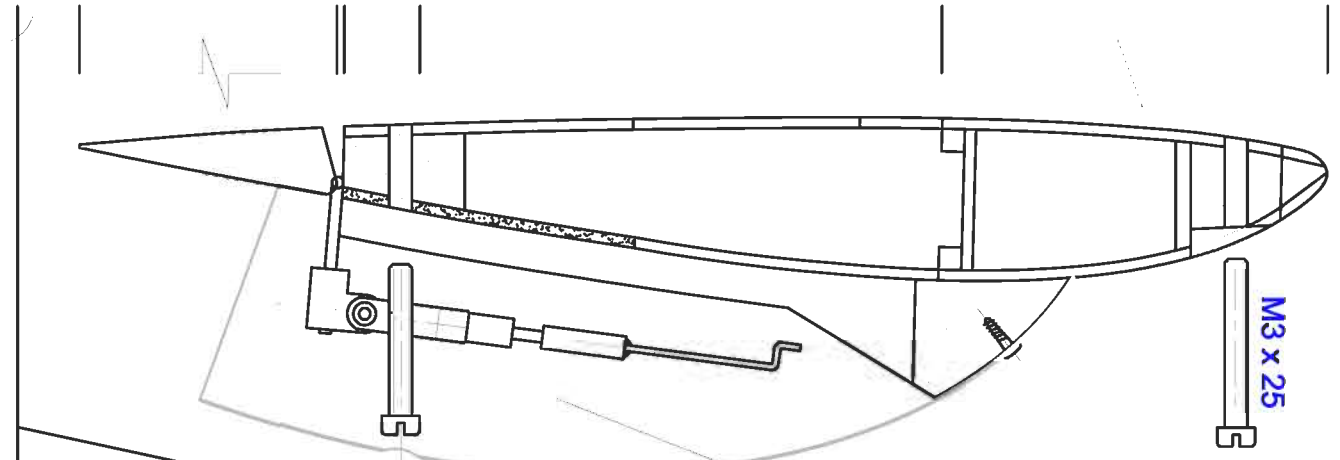

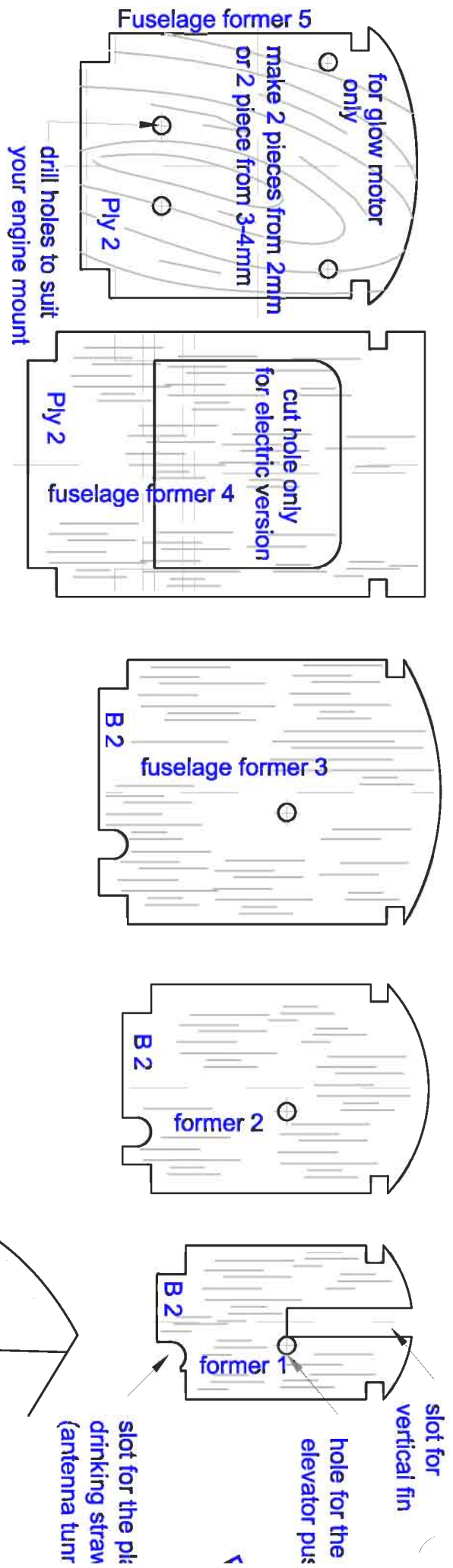
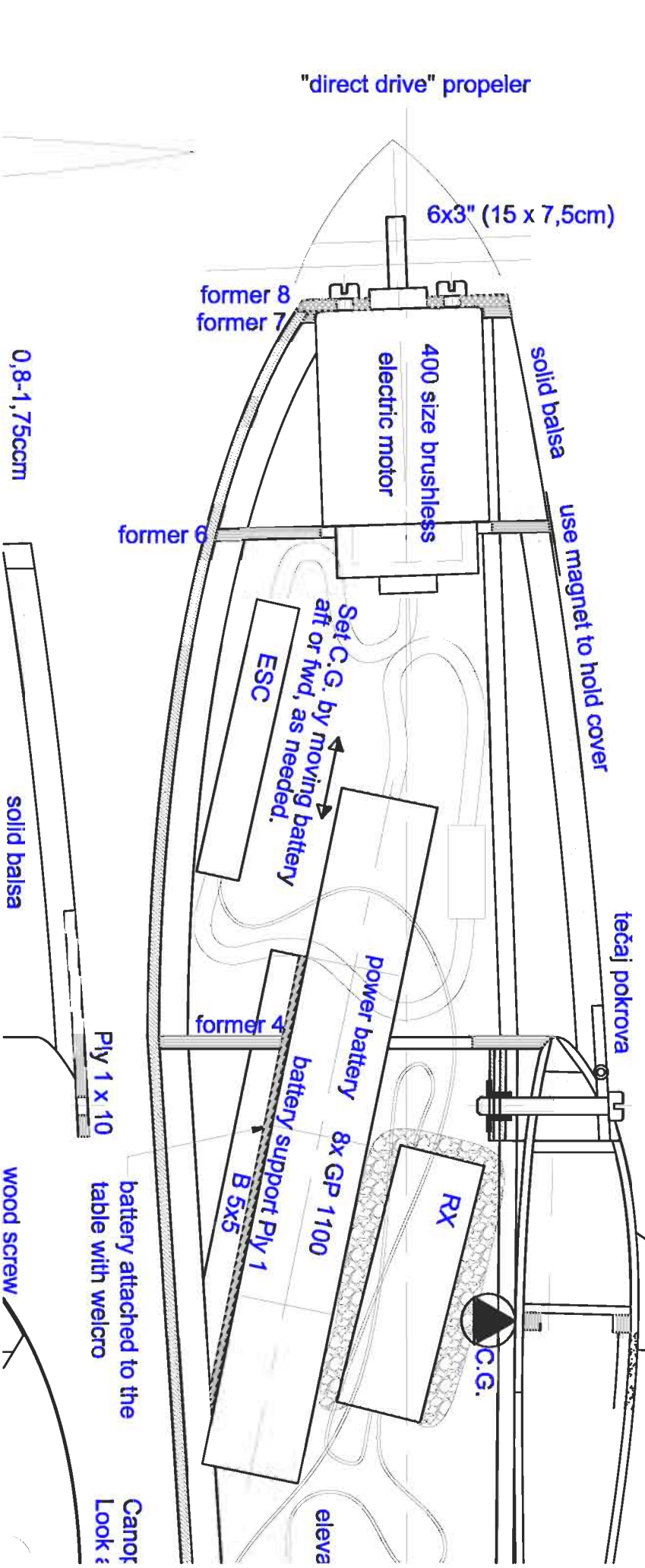

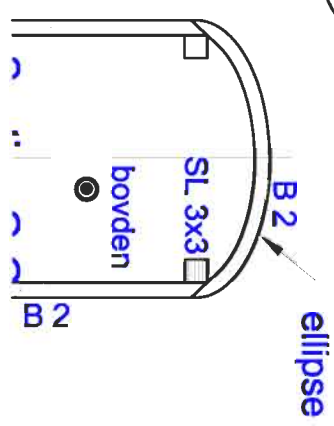
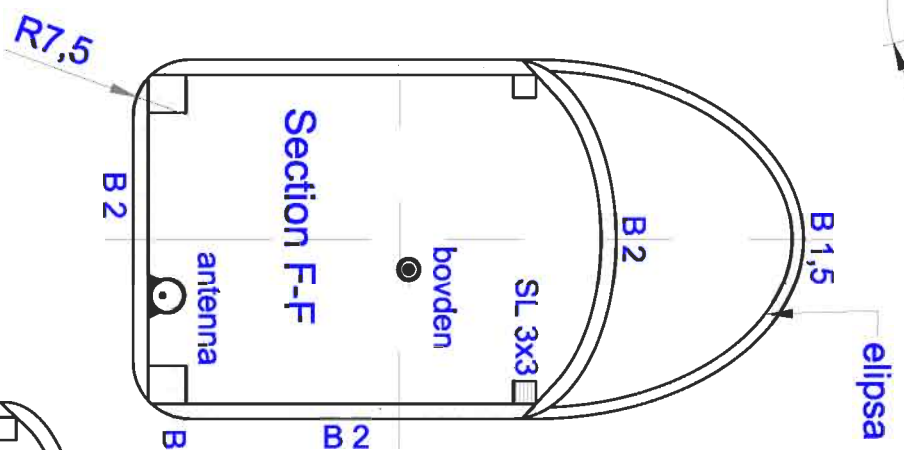
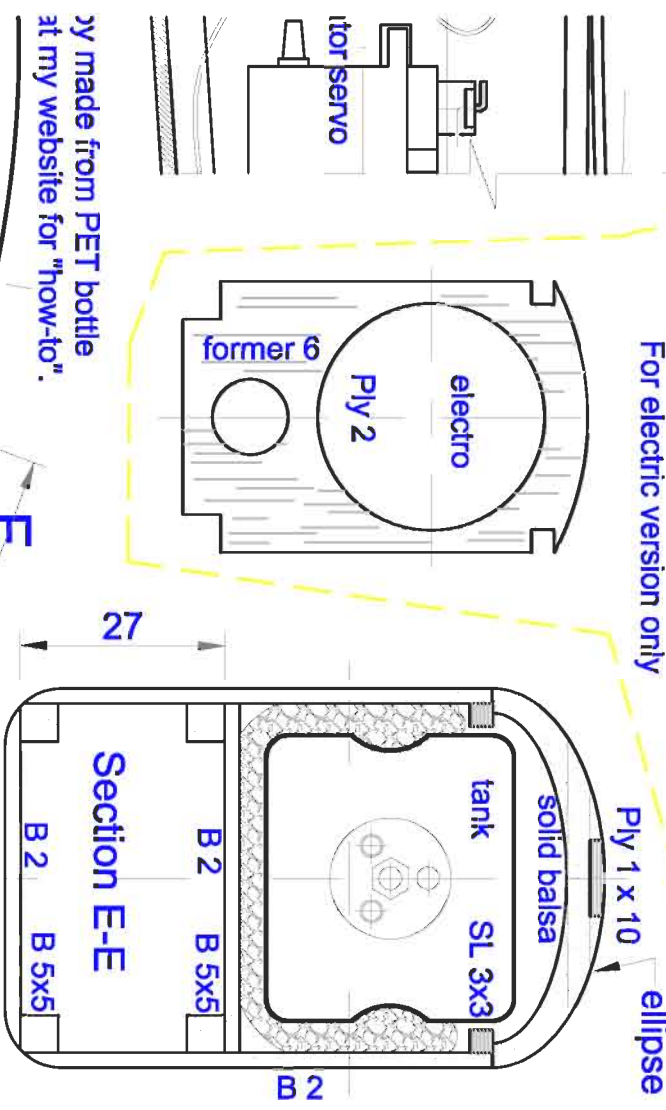
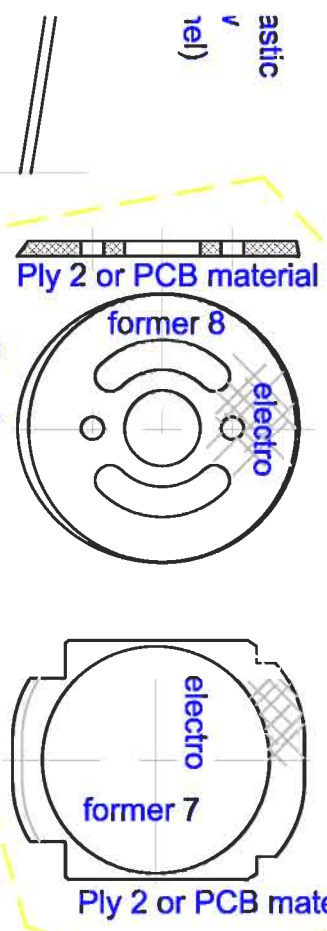
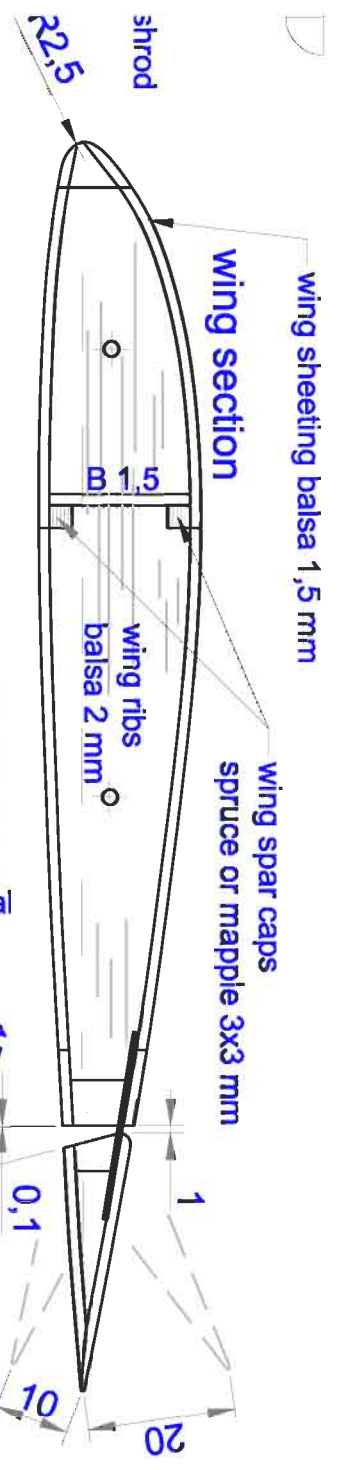

ny made from PET bottle  
at my website for "how-to".

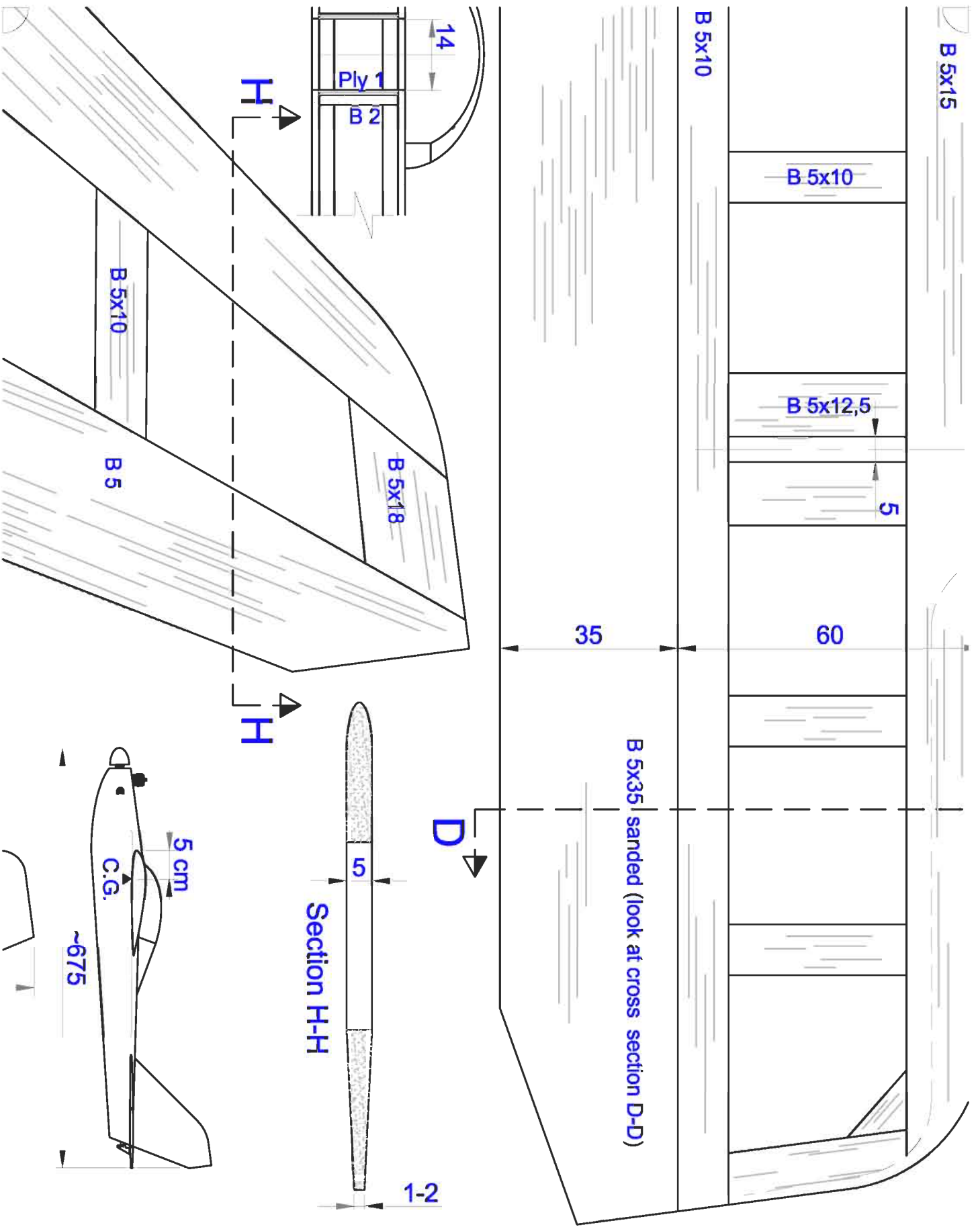



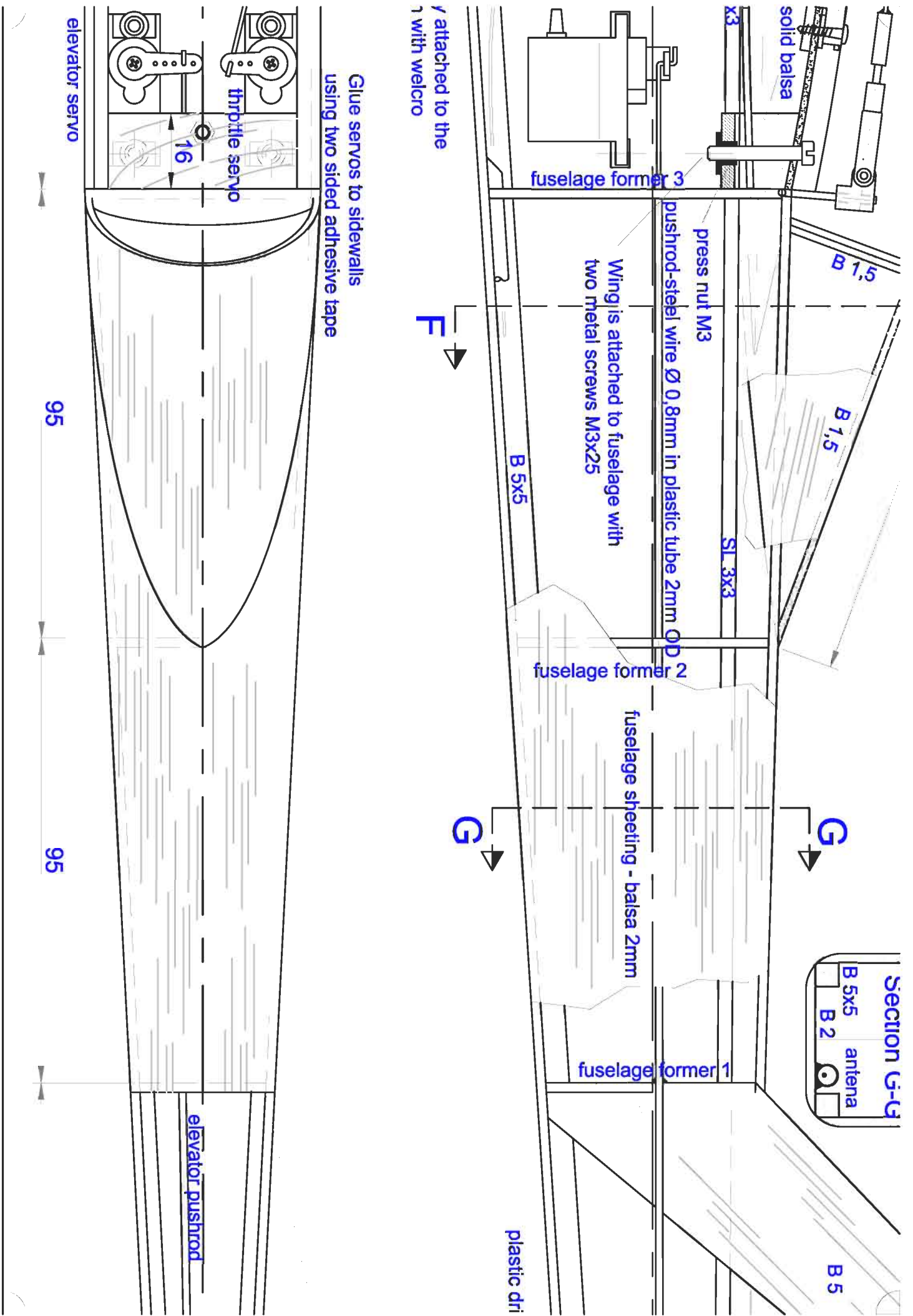

Y attached to the 1 with welcro

Glue servos to sidewalls using two sided adhesive tape

elevator servo

throttle servo

16

95

95

elevator pushrod

fuselage former 3

press nut M3

pushrod-steel wire Ø 0,8mm in plastic tube 2mm OD

Wingis attached to fuselage with two metal screws M3x25

B 5x5

fuselage former 2

fuselage sheeting - balsa 2mm

fuselage former 1

plastic dri

B 1,5

B 1,5

SL 3x3

Section G-G

B 5

F

G



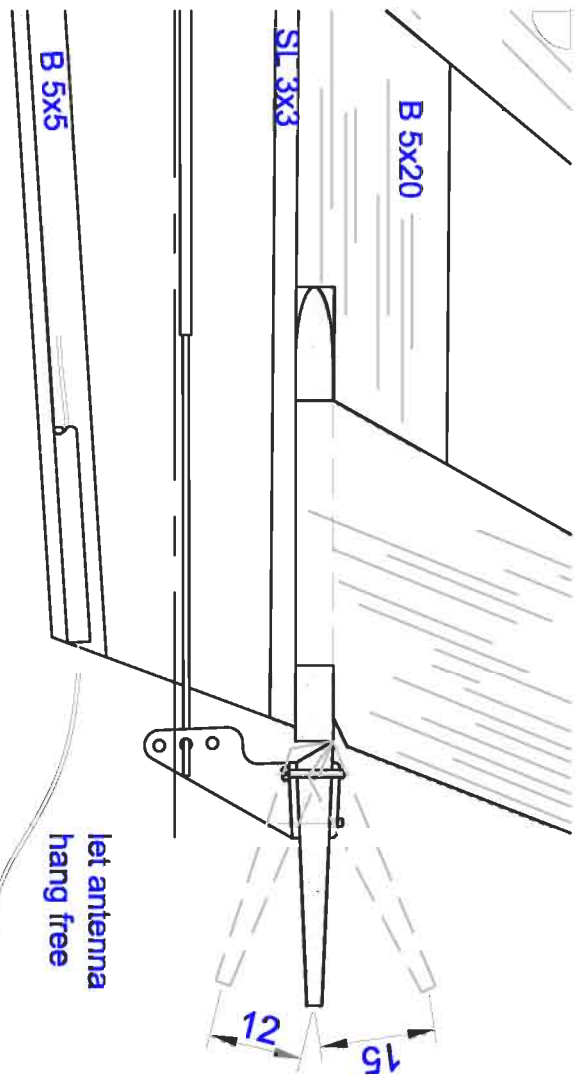

using straw as tunnel for RX antenna

horizontal tail

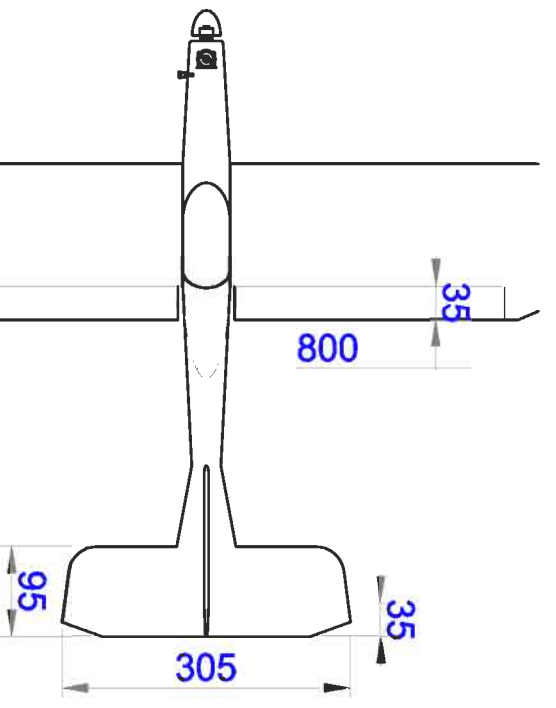
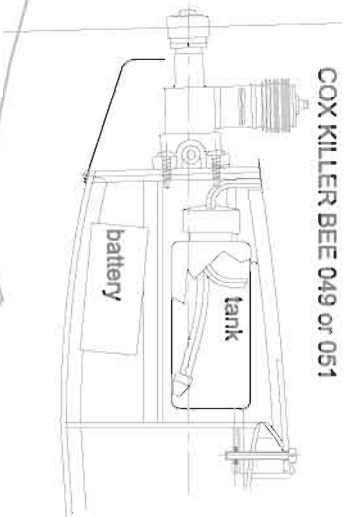

**MATERIAL LEGEND:**

- WP White Poplar
- Ply Plywood
- B Balsa wood
- SB Soft balsa wood
- HB Hard balsa wood
- SP Spruce wood
- PCB PCB composite material

**NOTE: USE LIGHT Balsa FOR ELECTRIC VERSION!!**

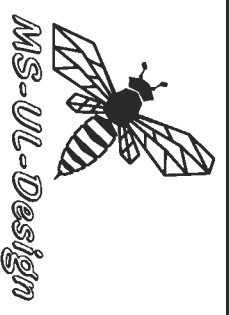
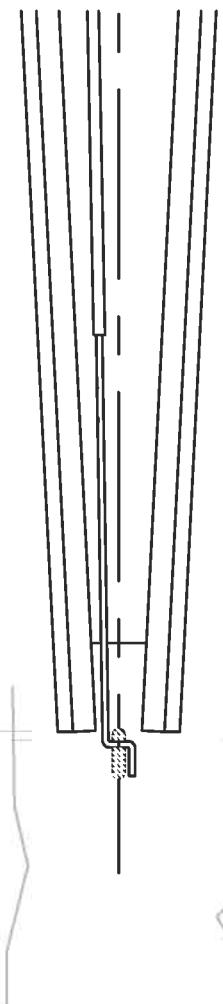

Model:	LITTLE SPORT PLANE
Drawing:	Complete plans
	01

Note: Designed by Ultralajt, feb.2004

Plans for personal use only.  
No commercial use allowed unless written permission from the author.